



MODELO STM RX  
**Base**  
**Calefactora**

## Descripción



STM RX EN USO

La base calefactora STM-RX que presentamos es una herramienta esencial para la industria, diseñada para facilitar el calentamiento eficiente de tambores de hasta 200 litros que contienen una variedad de sustancias cruciales para diferentes sectores industriales. Esta solución versátil combina potencia y control, brindando un rendimiento excepcional para optimizar procesos.

**ZERO**  
emission

## Contenido

- 1 Base Calefactora STM RX
- 2 Control BSG 04
- 3 Enchufe

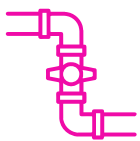
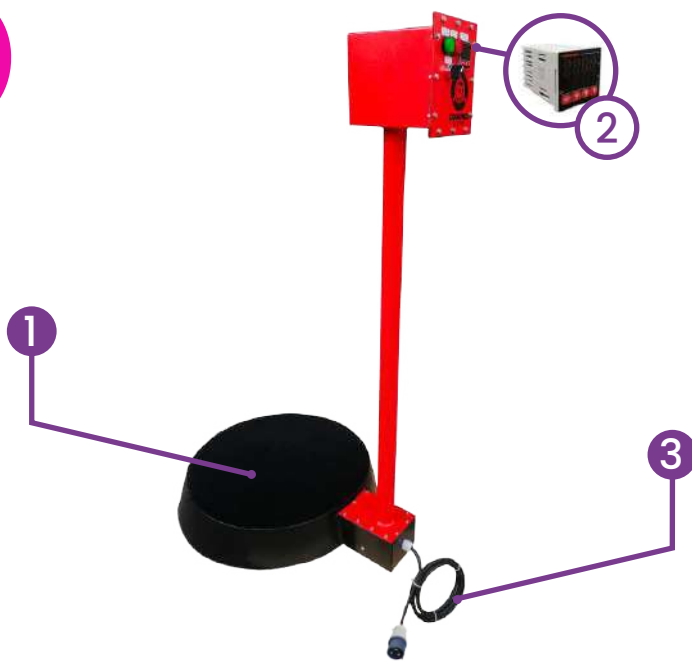

Tratamiento de Fluidos

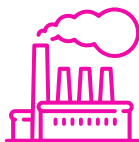

Ambientes Industriales



Industria Alimenticia

**RUBROS**

## Especificaciones técnicas

MODELO STM	
PESO	24,94 KG
POTENCIA	1500W
ALIMENTACIÓN	220V
CONTROLADOR	BSG 04
CAPACIDAD MAX.	TAMBOR 200L

## Dimensiones

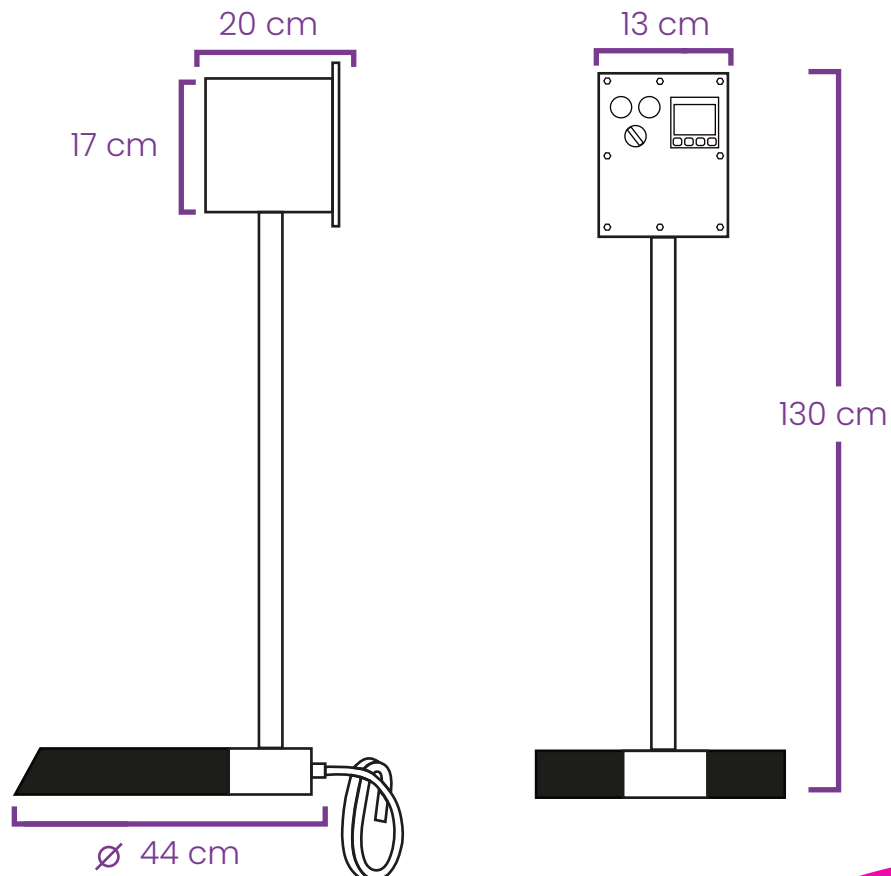





Industrial Molina ®



# Industrial

 Lanin 1634  
 [www.indumol.cl](http://www.indumol.cl)  
 [comercial@indumol.cl](mailto:comercial@indumol.cl)